

# Memo

**PUREPRO**  
DRINKING WATER SYSTEM

# S300

Quick-Change Cartridge

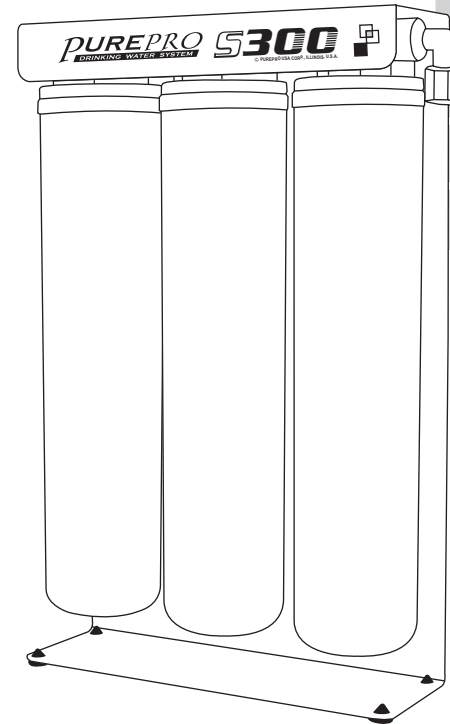

## USER'S MANUAL

- 01 Introduction of S300-C
- 02 Cartridge filters
- 03 Components & Other selections
- 04 Tubing connection diagram
- 05 Installation diagram
- 06 Change filters

Thank you very much for selecting Pure-Pro Water Corp.

In order to bring the best use of your system, please read the user's manual carefully before installation and follow the regulations.

Type of product	S300-C		
Date of purchase			
Name		Tel	
Address			

PURE-PRO 07 REVERSE OSMOSIS SYSTEM

S300 Quick-Change Cartridge Water Filters

**PUREPRO**  
DRINKING WATER SYSTEM

## Introduction of S300-C

### ◆ S300-C

Our S300 Countertop & Undersink Filters safely and effectively remove microorganisms like Giardia and Cryptosporidium from your water protecting you and your family from parasitic illnesses caused by these contaminants.

The patented quick-change filter technology also improves the taste and overall quality of your water by reducing the amount of Lead, Chlorine, Asbestos and other impurities often found in water supplies.

Efficient and easy to use, our S300 Countertop & Undersink Water Filters provide 1500 gallons (four to six months worth) of quality water and connecting directly to your tap, this water filtration product is convenient and practical. This unit will purify up to 1500 gallons of water by removing lead and other heavy metals as well as chlorine, bad tastes and odors.

### ◆ Features

- Complete 3 stage reverse osmosis water filter system.
- Use twist and quick-change cartridge design makes filter changes fast, clean and easy.
- Feed water connector & deliver valve
- Completely Assembled & Water leaking testing
- 100% Factory Tested and Sterilized Ready for Installation.
- European design golden type faucet.(optional )

### ◆ Specifications

Dimensions: (cm)16 (L) x 31.8(H) x 19.5 (W)

Weight: 3.5 kg

## Change filters

1. Turn off water source.

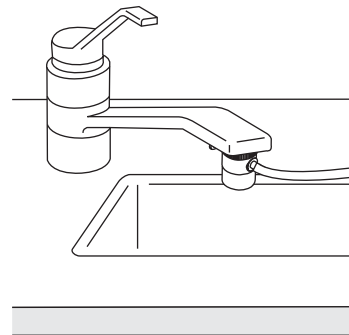

2. Loosen the used pre-filter clockwise and remove it.

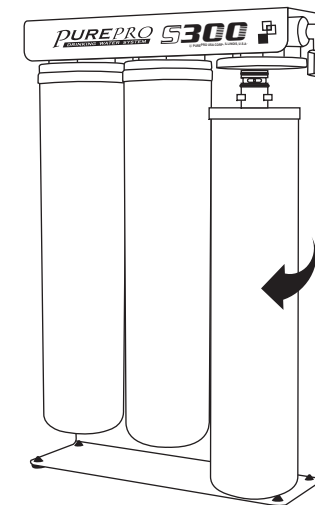

3. Screw in and install the new filter anticlockwise.

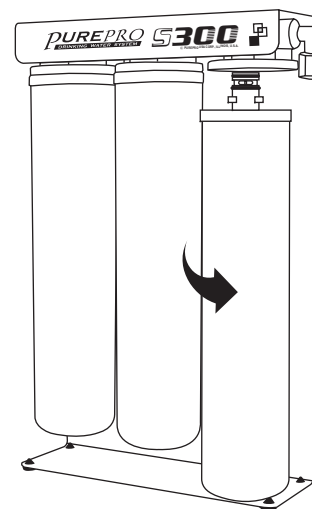

4. Turn on water supply.

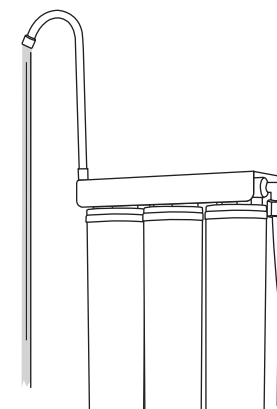

\*Drain out 1 Gallon of water to purify replacement filters.

## Installation diagram

### ©Install JACO :

Wrap up the jaco fitting with Teflon tape, screw in the fitting as shown in the picture.

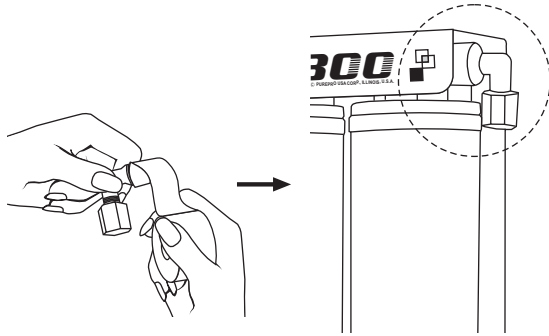

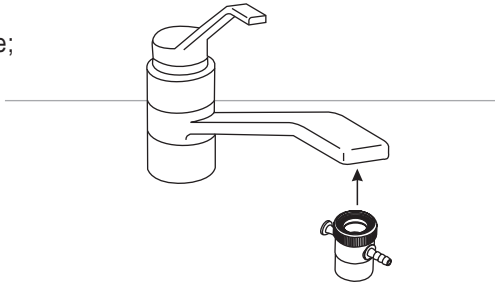

### ©Install faucet adaptor :

Screw in the adaptor to the faucet head clock-wise; make sure it is connected to the faucet head.

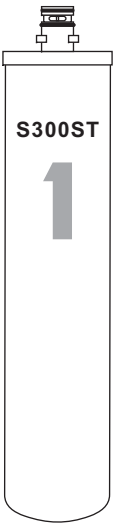

## Cartridge filters

### ◆ Filter Description

S300ST	S300ND	S300RD
		
<p><b>Stage 1</b> <b>5 Micron Sediment Filter</b></p> <p>With only five micron rating. It is effective in removing dirt, rust and sand particles.</p>	<p><b>Stage 2</b> <b>GAC Carbon Filter</b></p> <p>It takes out 99% of the chlorine and organic chemicals. It provides enhanced reduction of taste, odor, and color.</p>	<p><b>Stage3</b> <b>GAC Carbon Filter</b></p> <p>It takes out 99% of the chlorine and organic chemicals. It provides enhanced reduction of taste, odor, and color.</p>

# Components & Other selections

## ◆ Components

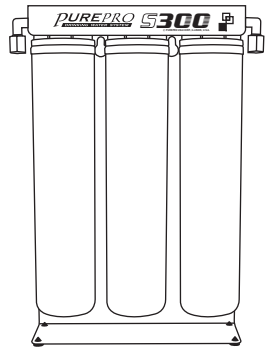

S300

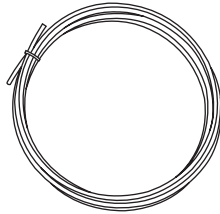

Tubing



Faucet adaptor

## ◆ Other selections

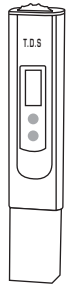

TDS meter

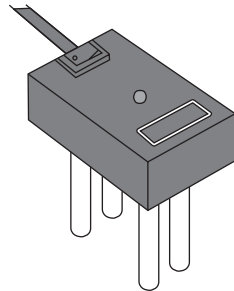

Electronic Color Tester



Shower filter

# Tubing connection diagram

- 1 In Let
- 2 Out Let

